

XURON
CORP

precisiontools

DESIGNED FOR CUTTING EXCELLENCE

Contents**shears**

- 2 Shear Facts**
Questions and Answers
- 4 9000 Series**
Micro-Shear® Flush Cutters
- 6 LX & Maxi-Shear™ Series**
Flush Cutters
- 8 Short Cut™ Series**
Micro-Shear® Flush Cutters
- 10 170-II Series**
Micro-Shear® Flush Cutters
- 12 Hand Tool Ergonomics**

**wire strippers, pliers
and forming tools**

13

specialty products

- 16 Rover Mask™**
Temporary Solder Resist
- 17 Micro-Pneumatic™ Series**
Flush Cutters
- 18 Tool Kits**
- 19 Wickgun™**
Braid Dispensers
- 20 800 Series Dispensing Bottles**
- 20 Static Control (AS) Grips**
- 21 Easy Reference Chart**

Xuron Corp. is one of the world's leading manufacturers of ergonomic electronics-grade hand tools for the electronics, aerospace, plastic molding, hobby, craft and jewelry industries.

Xuron sets the standard for precision, tool durability and ease of use. Unlike conventional cutting tools in which the cutting blades meet edge-to-edge (resulting in a spiked cut and eventual dulling of the tool), Xuron tools use our exclusive Micro-Shear® blade by-pass cutting action, which ensures clean cuts and improved durability.

Xuron holds numerous domestic and international patents, including an inventor's patent for the original Micro-Shear® flush cutter and its unique cutting action.

Xuron tools are manufactured in Saco, Maine, where quality, an outstanding work ethic and flawless craftsmanship are an enduring tradition.

Hundreds of distributors worldwide offer more than 100 different Xuron hand tools and associated products.

If you're looking to work with the best, choose hand tools designed for cutting excellence, manufactured only by Xuron.



shears

shear facts Q&A.

Q. Why do Micro-Shear® flush cutters cut so well?

A. The term Micro-Shear® flush cutter is a registered trademark of XURON CORP. and is applied only to our products which utilize our patented, blade by-pass shear cutting action.

Conventional wire cutters utilize a compression-type cut, with the advancing cutting edges forcing the metal of the wire out of their way.

Micro-Shear® flush cutters utilize a shearing cut, with the by-pass cutting edges slicing cleanly through the metal (see illustration at bottom of adjacent page).

Shear cutting greatly reduces mechanical shock delivered to the component and requires only about half the effort to cut a wire as compared to conventional compression-type wire cutters.

Q. What's the difference between a Micro-Shear® flush cutter and a conventional wire cutter?

A. All primary cutting surfaces on our 170-II, 410 and LX Series Micro-Shear® flush cutters are generated on high precision, three microprocessor-controlled, self diagnostic grinding equipment. The grinding on every blade is as precisely identical to that on every other blade as their computer controlled tolerances allow. It is also exactly the same type of grinding as used on such fine tools as LINDSTROM® and EREM®.

We're not suggesting any company use XURON Micro-Shear® flush cutters instead of these other great tools, but why should you sacrifice that level of quality just because your requirements call for "economically priced" tools?

Q. Why do Micro-Shear® flush cutters last so long?

A. XURON Micro-Shear® flush cutters ensure durability by design. Let's use a little basic physics to illustrate how:

If you generate 10 pounds of pressure on the grips of a conventional, compression-type wire cutter to cut a wire, that 10 pounds of force must be dissipated somewhere (Law of Conservation of Energy). Part of it is dissipated into the severed section of wire, which is why it sails across the room. A portion travels down the lead wire and is dissipated into the component or solder joint,



which can cause damage. The balance is dissipated into the opposing cutting edge of the cutter, which is why they get dull.

Using a Micro-Shear® flush cutter requires only about half the pressure (approximately 5 pounds) to cut the same wire. Part of the force is dissipated into the severed section of the wire. But if you're using our patented lead retainer the wire won't sail across the room. Because of our shearing cut very little is dissipated into the component or solder joint; the rest is dissipated into the opposing cutting jaw. Because of our blade by-pass, edge-to-edge contact is eliminated and the life of our Micro-Shear® flush cutter's precision cutting edges is extended.

Q. What is the difference between a stamped tool and a drop-forged tool?

A. Precision stamped Micro-Shear® flush cutters have more in common with precision drop-forged tools than with conventional drop-forged tools.

The most obvious difference is that the blank shape of a drop-forged tool is created from hot metal. A stamped tool does not require heat at this stage. Beyond this point the differentiation becomes less distinct.

In conventional drop-forging a crude, basic shape is created. With precision drop-forging a more refined shape with reference points for subsequent grinding operations is created. Conventional drop-forged tools typically then undergo hand-guided grinding operations. With precision drop-forged tools these grinding operations are usually done with computer controlled machines utilizing the reference marks on the blank.

When we manufacture precision stamped Micro-Shear® flush cutters a refined shape, complete with reference points for our computer controlled grinding operations, is generated in the stamping process.

All tools, regardless of the method of manufacture, have to be heat treated. In the electronics industry return springs and cushion grips are required. The distinction between drop-forged and stamped tools is further blurred since, due to the high density areas electronics pliers are required to be able to work in, one of the more popular head configurations on drop-forged tools is the "relieved head." On these tools additional grinding operations remove head stock to reduce the tool's profile, increasing access and maneuverability. The result is a head shape very similar to our standard XURON Micro-Shear® flush cutter.

Compression cutter blades meet edge-to-edge, causing a spiked cut and an eventual dulling of the tool.

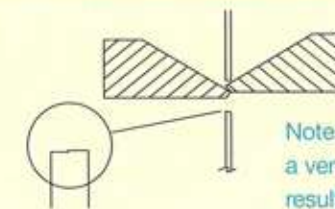
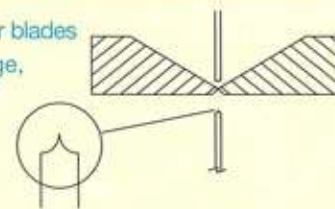

This is a cross section view of a XURON Micro-Shear® flush cutter from the tip end.

Note how the blades by-pass – this is a very important patented feature that results in a clean square cut with no spikes.

The ultimate shear cutter

Our 9000 Series is the culmination of 20 years of continuous development of the Micro-Shear® cutter. These are the only shears made anywhere in the world rated for cutting everything from soft material less than one mil. up to 12 AWG copper wire.

9000 Series Micro-Shear® flush cutters begin with a unique, state of the art blanking process from a tough alloyed steel. Their size and shape reflect the latest advances in enhanced ergonomics. The heat treating process is exclusive to the 9000 Series. Cutting edges are an ultra durable 56-58 RC. The result is a shear unlike any other in design, capacity and durability. Static dissipative grips are optionally available.

The Long Handled (LH) variation of the 9000 Series is designed for applications where workplace ergonomics call for an extra long handled tool. They provide added leverage for reduced cutting effort. Longer handles also create an extended contact area with the hand for a more secure grip and more repositioning possibilities. This decreases pressure within the hand at any given point reducing fatigue associated with repetitive motion.

The 9000 Series is the ultimate shear cutter, available only from XURON, the company that invented the Micro-Shear® flush cutter.

9100F Micro-Shear® Flush Cutter

Our 9100 with a factory installed lead retainer. Ultra low profile design provides excellent access while special no-slip mounting ensures accurate positioning on the shear. Helps prevent flying leads and component shorting from stray leads.

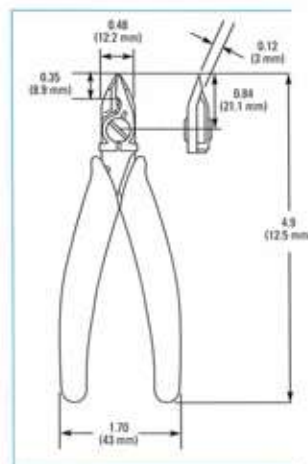

9100LH Oval Head Micro-Shear® Flush Cutter

Our 9100 with extra long handles. Same tough alloyed steel, heat treating, grinding and ergonomic shape combined with added handle length and extra long Xuro-Rubber™ grips. Reduces pressure on operator's hand at any given point; offers more repositioning possibilities. Flush cuts soft wire up to 12 AWG (2.0 mm).

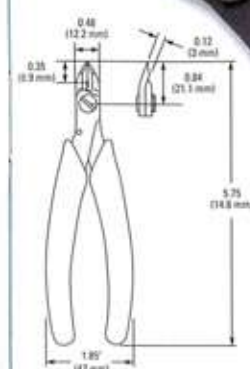

9200 Tapered Head Micro-Shear® Flush Cutter

Tapered head version of the 9100. The same tough alloyed steel, heat treating and ultra-precise CNC grinding with a tapered head for improved access in high density areas and added precision. Tapered head design allows positioning, even on fine pitch leads. Precision-ground Micro-Shear® cutting edges guarantee a clean cut. Flush cuts soft wire up to 14 AWG (1.6mm).

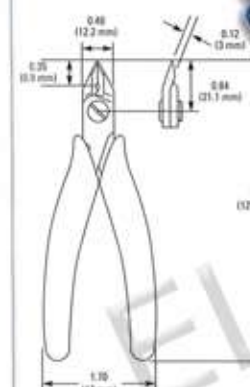

9200F Micro-Shear® Flush Cutter

Our 9200 with a factory installed lead retainer. Ultra-low profile design provides excellent access while special no-slip mounting ensures accurate positioning on the shear. Helps prevent flying leads and component shorting from stray leads.

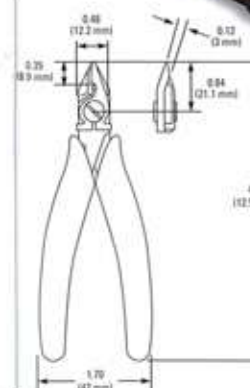

9180 Kevlar® Fiber Shear

Designed and manufactured specifically for cutting the Kevlar® fiber strength component of fiber optic cables. Uniquely designed serrated edge prevents the fibers from sliding out the front of the shear while cutting. Cutting edges are heat treated to a hard 58-60 RC. A superior tool offering both precision cutting and exceptional tool life. Cushioned Xuro-Rubber™ grips and return spring provide both comfort and convenience.

9180NS (non-serrated) Shear

The same as our standard model 9180 but without the serrated edge. Designed for cutting applications where serrations are not necessary or not desired. Appropriate for cutting soft sheet metals up to 0.031" (0.8mm).

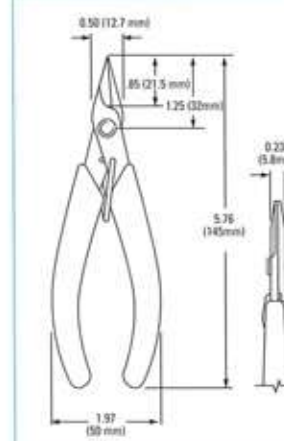
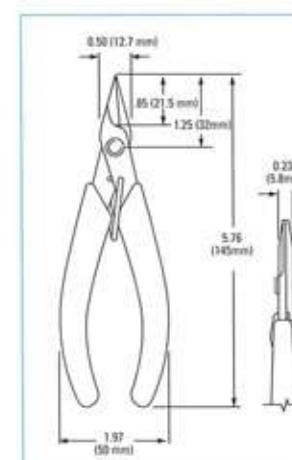

9200LH Tapered Head Micro-Shear® Flush Cutter

Our 9200 with extra long handles. Same tough alloyed steel, heat treating, grinding and ergonomic shape combined with added handle length and extra long Xuro-Rubber™ grips. Reduces pressure on operator's hand at any given point. Offers more repositioning possibilities. Flush cuts soft wire up to 14 AWG (1.6 mm).

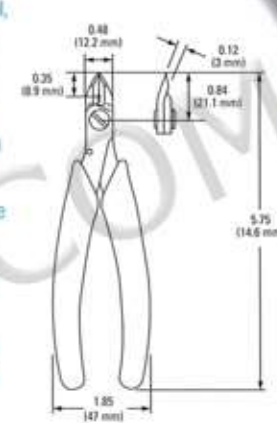
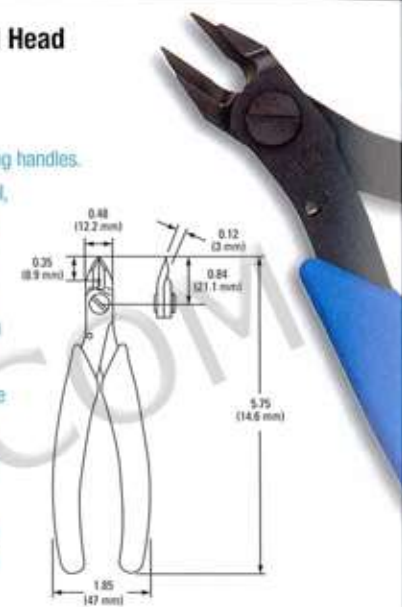

9250ET (Extra Tapered) Micro Shear® Flush Cutter

Features a subminiature (Extra Tapered) head size for access into extremely restricted areas. Ideal for ultra high density circuit boards and SMT. Design offers strength with the superior durability of all 9000 Series shears. Ergonomically shaped, cushioned Xuro-Rubber™ grips and our Light Touch™ return spring for operator comfort. Glare eliminating black finish helps reduce eye strain and enhances contrast for more precise positioning. Cuts from less than one mil up to 18 AWG (1.02 mm).

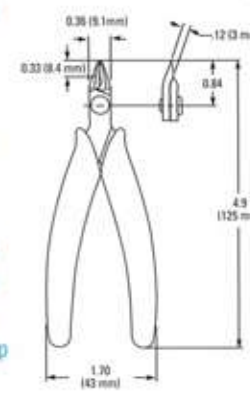

Upgraded for the 21st century, the LX Series Micro-Shear® Flush Cutters are stronger and more durable with improved cutting capacity. These mid-range flush cutters feature precision-ground, ultra-sharp cutting edges on a tool designed for maximum strength and durability. State of the art heat treating to Rockwell 55-57C ensures a rugged, precise, and extremely durable flush cutter capable of cutting soft leads up to 16 AWG (1.29 mm). Features also include ergonomic design, non-slip Xuro-Rubber™ grips, a glare resistant bright finish and our patented, lifetime warranted, *Light Touch™* return spring.

LX Series shears are optionally available with static control (AS) grips

LX Micro-Shear® Flush Cutter

Our patented Micro-Shear® cutting action combined with precision ground cutting edges, extra tough .100" thick high carbon steel blades, and an ultra slim profile for access in high density areas. Sized for smaller hands and maximum maneuverability. Flush cuts soft wire up to 16 AWG (1.29 mm).

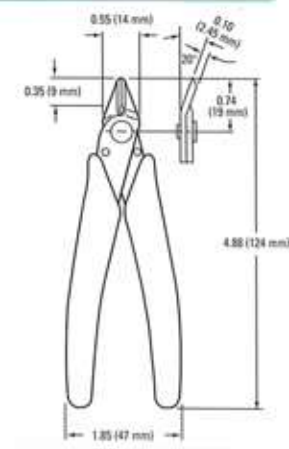

LX-F Micro-Shear® Flush Cutter

Our LX with a factory installed lead retainer. Design provides a low profile and non-slip mounting on the shear. Helps prevent flying leads and component shorting from stray leads.

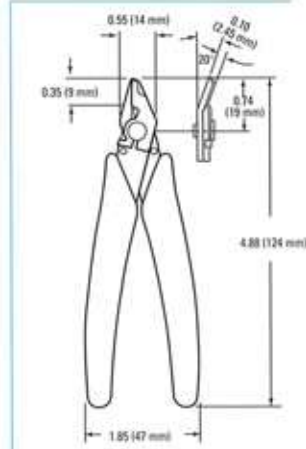

LX-T Micro-Shear® Flush Cutter

A special, extra tapered cutter head with an ultra-slim tip profile combined with the same Micro-Shear® cutting action, precision grinding, and tough high carbon steel blades of the standard LX. Ultra-sharp, precision tip for access in highly restricted areas. Flush cuts soft wire up to 20 AWG (0.8 mm).

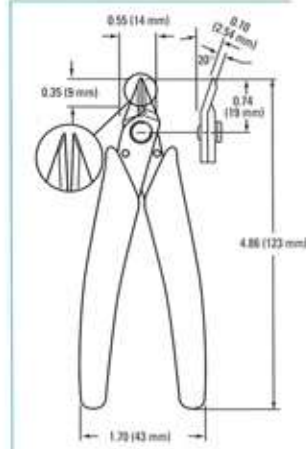

2175 Maxi-Shear™ Flush Cutter

An extremely durable and versatile wire cutter featuring our patented Micro-Shear® cutting action. Tough enough for harnesses and cables with the precision to cut material less than 1 mil. thick or work in high density areas. Ergonomically shaped, non-slip Xuro-Rubber™ grips and a glare eliminating black finish ensure operator comfort. Non-protruding, lifetime warranted flat spring provides excellent "feel" without excessive spring tension. Flush cuts soft wire up to 12 AWG (2.05 mm).

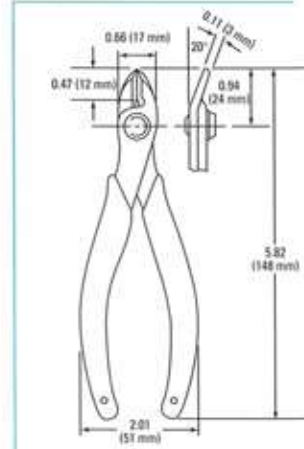

The 2175 Maxi-Shear™ Series flush cutters are manufactured from the highest grade, 0.125" high carbon steel. They feature our lifetime warranted, *Light Touch™* return spring and ergonomically-shaped, non-slip Xuro-Rubber™ grips. Most important, all 2175 Maxi-Shear™ flush cutters utilize our patented Micro-Shear® cutting action. This means less cutting effort, less fatigue, and fewer fatigue-related injuries and complaints. Maxi-Shears™ are optionally available with static control (AS) grips.

2175A Maxi-Shear™ Flush Cutter

Ultra flush cutting version of our 2175 for fine work and very soft materials. Very lightly bevelled cutting edges allow for minimal blade by-pass (see diagram) ensuring the finest flush cut possible. Glare eliminating black finish and ergonomically-shaped Xuro-Rubber™ grips. Cuts soft wire up to 14 AWG (1.6 mm).

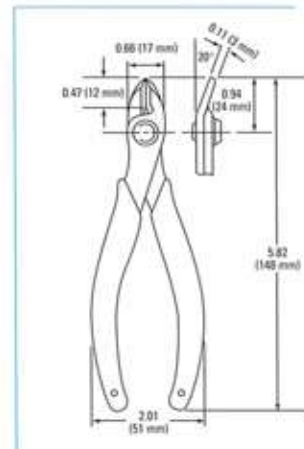
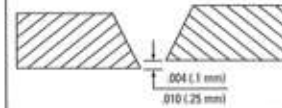

2175B Maxi-Shear™ Flush Cutter

Semi-flush cutting version of our 2175. A more pronounced bevel on the cutting edges (see diagram) allows for heavier cutting or extended wear where flush or ultra flush cuts are not required. Non-slip, ergonomically shaped Xuro-Rubber™ grips and a glare eliminating black finish for operator comfort. Semi-flush cuts on soft wire up to 12 AWG (2.05 mm).

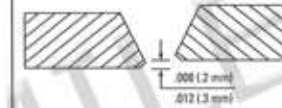

2175F Maxi-Shear™ Flush Cutter

Our 2175 with a factory-installed lead retainer. Clip is permanently installed for non-slip positioning. Low profile design for good sight lines and accessibility. Helps prevent flying leads and component shorting from stray leads.



2193 Music Wire Shear

Large, full by-pass shear designed specifically for cutting music wire and other types of hardened wire. Shearing cut combined with high mechanical advantage make cutting iron, hardened and tempered steel wire up to 12 AWG (2.05mm) seem effortless. Cushioned Xuro-Rubber™ grips and our *Light Touch™* return spring for operator comfort. Cuts music wire up to 0.040" diameter.

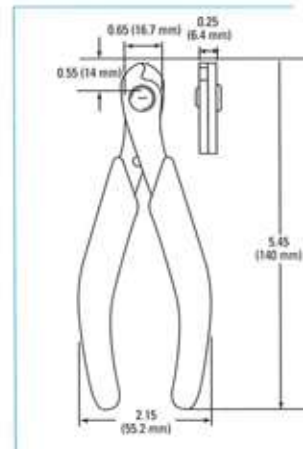

2193F Music Wire Shear

Our 2193 with self-adjusting clamping fixtures which hold the material being cut perpendicular to the cutter jaws. Greatly simplifies cutting process while adding significantly to both the precision of the cut and cutting capacity. Gives square ended cuts on both the cut and off-cut sides. Cuts music wire up to 0.060".

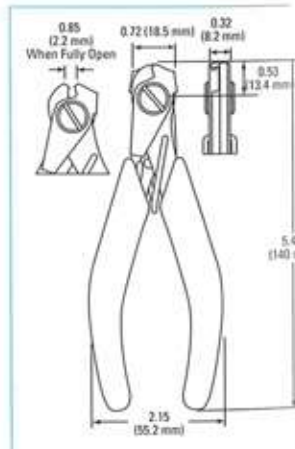

Short-Cut™ Series shears feature an ergonomically-enhanced size and shape. Hand grip dimensions are optimized to fit the size and shape of the human hand. Their unique shape and Xuro-Rubber™ grips provide a secure "fit" in the operator's hand resulting in more precise control.

Short-Cut™ Series shears feature a glare eliminating black finish for operator comfort and enhanced contrast between the component lead and tool and our patented, lifetime warranted, *Light Touch™* return spring.

Static dissipative grips are optionally available.

410 Micro-Shear® Flush Cutter

This premium grade version of our world famous 170-II Micro-Shear® Flush Cutter. Its size and shape are optimized for work in high density areas. The patented Micro-Shear® blade by-pass reduces both cutting effort and mechanical shock (impact) transmitted to the component. High carbon steel blades are precision ground to ultra sharp cutting edges. The unique, state of the art heat-treating process yields a Rockwell hardness of 55-57C. The result is a light, precise, durable flush cutter capable of reliably and economically cutting soft wire up to 18AWG (1.02mm).



410F Micro-Shear® Flush Cutters

Our 410 with a factory-installed lead retainer. Design provides a low profile and non-slip mounting on the shear. Helps prevent flying leads and component shorting from stray leads. Cuts soft wire up to 18 AWG (1.02mm).



410T Micro-Shear® Flush Cutter

Our 410 shear with ultra sharp precision tips and an extra thin tip profile. Provides the ultimate in maneuverability and operator control; allows work in areas other tools cannot even enter. Ideal for SMD or high density areas. Due to the low mass of the cutter head, care should be exercised to avoid overstressing the tips. Maximum cutting capacity is 22 AWG (0.64mm) soft wire.



410A Micro-Shear® Flush Cutter

A flush cutting version of our 410, for fine work. Very lightly bevelled cutting edges allow for minimal blade by-pass (see diagram) ensuring the best flush cut possible while still retaining the Micro-Shear® blade by-pass type of cut. Glare eliminating black finish and ergonomically shaped, non-slip Xuro-Rubber™ grips for operator comfort. Cuts soft wire up to 20 AWG (0.8 mm).

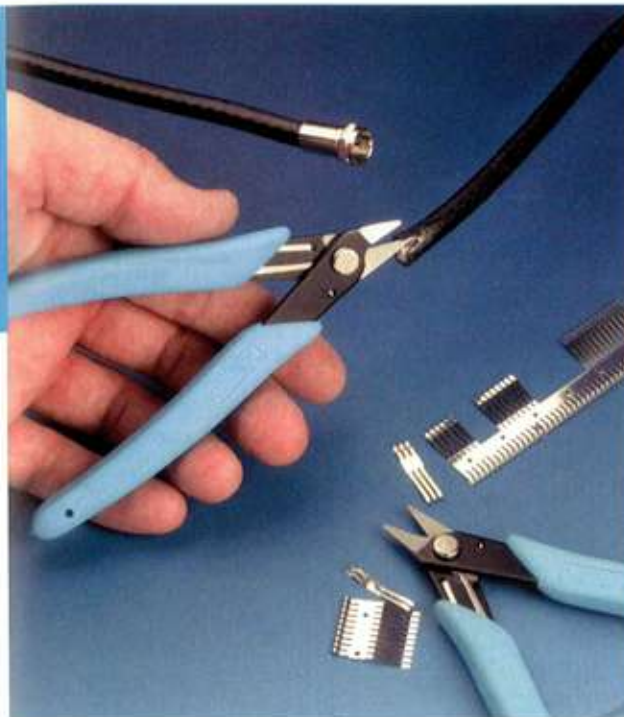
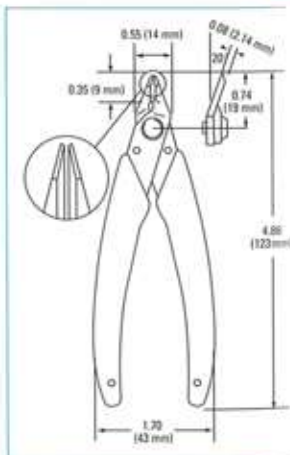
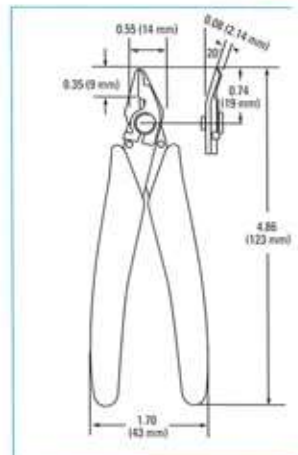
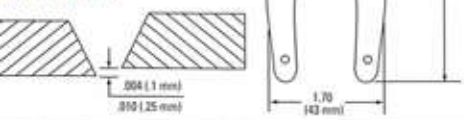

420T Angled Micro-Shear® Flush Cutter

Our 420 shear with ultra sharp precision tips and an extra thin tip profile. Provides the ultimate in maneuverability and operator control; allows work in areas other tools cannot even enter. Ideal for SMD or high density areas. Due to the low mass of the cutter head, care should be exercised to avoid overstressing the tips. Maximum cutting capacity is 22 AWG (0.64 mm) soft wire.

440 Mini-Shear

An ultra precise scissor, cuts fine or delicate items with a clean, square edge. Cushion grip, Xuro-Rubber™ handles and our *Light Touch™* return spring replace conventional finger loops for increased comfort and precision. This innovative design is especially advantageous for users with arthritic hands. Rated for cutting soft metals up to 0.005".

420 Angled Micro-Shear® Flush Cutter

Allows easier cutting in difficult areas. Angled head provides excellent sight lines when used in either the vertical or horizontal position. Slim profile for accessibility. Glare eliminating black finish, non-slip Xuro-Rubber™ grips and light weight for operator comfort. Flush cuts soft wire up to 20 AWG (0.8 mm).

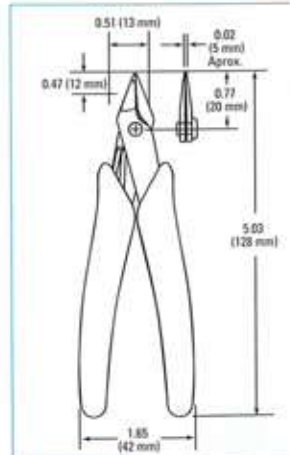
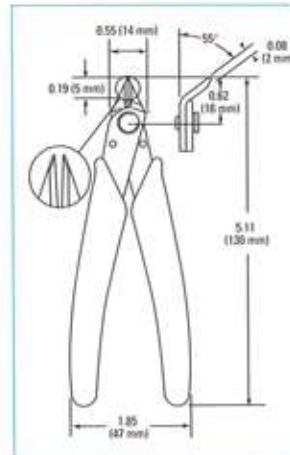
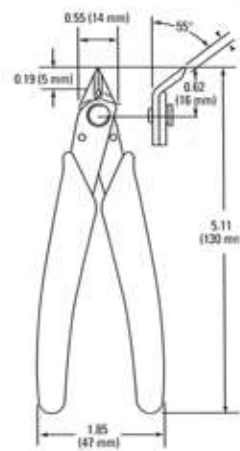

170-II Micro-Shear® Flush Cutter

Our world famous, patented original Micro-Shear® flush cutter sets the standard imitators can't meet. We invented it. We perfected it. We were awarded the patent (U.S. Pat. 3774301).

Shear cutting greatly reduces cutting effort while providing the shear cut desirable in electronics assembly work. Less cutting effort means fewer fatigue related injuries and complaints.

The ergonomically shaped, non-slip Xuro-Rubber™ grips, glare eliminating black finish and light weight ensure operator comfort.

Ultra slim profile increases access in high density areas. Flush cuts soft wire up to 18 AWG (1.0 mm).

170-IIA Full Flush Cutting Micro-Shear® Flush Cutter

The 170-IIA is an ultra flush cutting version of our 170-II, for fine work. Very lightly bevelled cutting edges allow for minimal blade by-pass (see diagram) ensuring the finest flush cut possible while still retaining the Micro-Shear® blade by-pass type of cut. Glare eliminating black finish and ergonomically shaped, non-slip Xuro-Rubber™ grips ensure operator comfort. Cuts soft wire up to 20 AWG (0.8mm). The 170-IIA is a good choice for plastics de-gating.

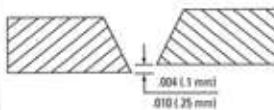

170-II Series shears offer numerous ergonomic enhancements in an "economically priced" tool. Their effort-reducing Micro-Shear® cutting action requires only about half the effort to cut a wire as that required by conventional compression-type cutters. The 170-II Series feature advanced ergonomic shape, Xuro-Rubber™ grips, a glare eliminating black finish, light weight and our patented, lifetime warranted, *Light Touch™*

170-IIF Micro-Shear® Flush Cutter

The 170-IIF features a low profile, non-slip, factory-installed lead retainer to help prevent flying leads and component shorting from stray leads.

280-II Angled Micro-Shear® Flush Cutter

The 280-II allows easier cutting in difficult areas. A 55° angled head provides excellent sight lines when used in either the vertical or horizontal position. A slim profile increases accessibility to hard to reach surfaces. Light weight, glare eliminating black finish, non-slip Xuro-Rubber™ grips ensure operator comfort. Flush cuts soft wire up to 20 AWG (0.8 mm).

635 Shear Rise Cutter

The 635 Shear Rise Cutter combines a full flush, shear cut and a 0.035" stand off in one cut. It's ideal for manufacturers who need both a stand off and a full flush cut. Glare eliminating black finish, ultra light weight and ergonomically-shaped, non-slip Xuro-Rubber™ grips ensure operator comfort. High carbon steel guarantees durability. Full flush cuts on soft wire up to 20 AWG (0.8 mm).

670 Cut and Crimp Tool

The 670 Cut and Crimp Tool features a slim profile (0.085") that allows accessibility in high density areas and provides excellent sight lines for precise positioning. Swaged leads are firmly attached to p.c.b., while freshly exposed lead material enhances solderability. High carbon steel guarantees durability. Ultra light weight, glare eliminating black finish and ergonomically shaped, non-slip Xuro-Rubber- grips ensure operator comfort. Cuts and crimps soft wire up to 20 AWG (0.8 mm). Best results are achieved when the diameter of the hole on the p.c.b is not larger than 2.5 times the diameter of the wire being cut/crimped.

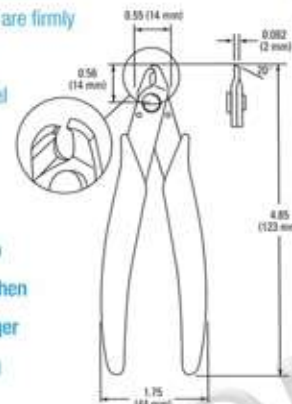

670HD Heavy Duty Cut and Crimp Tool

The 670HD offers the same great features as our 670 Cut and Crimp tool in a heavy-duty configuration. A larger head (0.115") simplifies positioning and heavy-duty construction provides extended tool life and larger wire capacity. Light weight, glare-eliminating black finish and ergonomically-shaped, non-slip Xuro-Rubber™ grips ensure operator comfort. Cuts and crimps soft wire up to 16 AWG (1.27 mm). Best results are achieved when the diameter of the hole on the p.c.b is not larger than 2.5 times the diameter of the wire being cut/crimped.

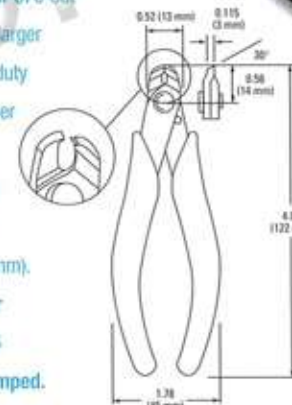

8500 BioShear® Flush Cutter

Bio-Shear® flush cutters incorporate the popular curved grip design with all the ergonomic features of our standard 170-II. Grip design keeps the knuckles of the operator's hand in a straighter line and prevents the hand from completely closing, reducing the amount of effort expended while delaying fatigue. Heat treated to 54-56RC for lasting durability. Please designate either 8500L(left) or 8500R(right).

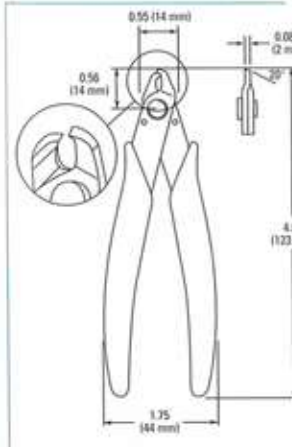
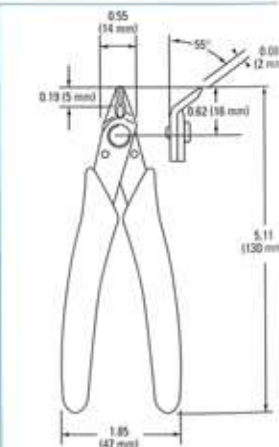
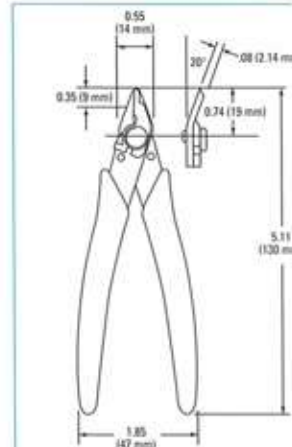
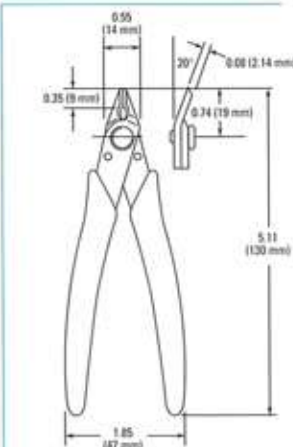
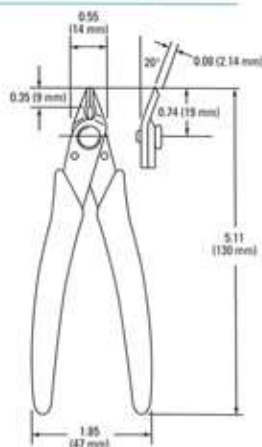

and tool ergonomics Q&A.

Q. What are ergonomic hand tools?

A. All hand tools, by definition, are ergonomic, otherwise you wouldn't be able to do any work with them. What's really important are the ergonomic enhancements that have been (or can be) made to your tools. Let's examine several different aspects:

1. Force — The amount of force required to use a tool includes the force necessary to overcome resistance in joints and any return spring(s) in addition to the force actually required to cut, grasp or bend. XURON manufactures only Micro-Shear® wire cutters. Their patented shearing cut requires about half the force required by a conventional compression-style cutter to cut wire. High precision screw and post joints on the 9000 Series reduce internal friction and our return springs provide lively action with low operating pressure.

2. Comfort — A number of factors determine if a hand tool is comfortable: the shape of the grip and its size, the amount of contact surface with the hand and the contour of the contact surface, the resiliency of the grip material, and the overall weight of the tool; all influence whether the tool will be comfortable in your hand. The comfort of the tool should be apparent the moment it's picked up. Comfort should also be assessed after extended use.

Micro-Shear® Flush Cutter grips feature broad, flat contact surfaces molded from Xuro-Rubber™. The grips on the 9000LH tools traverse the width of the hand, helping to eliminate pressure points while reducing pressure at any given point. Grip spread in the closed position is under 2", a comfortable dimension for most hand sizes. Weight is very low, ranging from 1.9 oz. for a 170-II to 2.7 oz. for a 9000LH Series shear.

3. Visual — Reflective surfaces cause glare, which promotes eye strain and fatigue. Positioning, especially in dense areas or under adverse lighting conditions, is troublesome and fatiguing if there is poor contrast between the tool and the workpiece.

XURON tools feature a non-glare bright finish or a



glare-eliminating black finish, giving you the option of selecting the appropriate finish for the work.

4. Auditory — High sound levels in the workplace are another important fatigue factor. XURON 590 Micro-Pneumatics™ help reduce workplace noise levels with their quiet operation (<60 DbA).

Q. Will hand tools with ergonomic enhancements eliminate cumulative trauma disorders (CTD), such as carpal tunnel syndrome?

A. No. No hand tool, regardless of ergonomic enhancement is capable of being a "magic bullet" and eliminating possible cumulative trauma disorders. The enemy is still the repetitive nature of the work and fatigue. With ergonomically-enhanced hand tools fatigue is postponed and trauma is reduced. The goal is to postpone fatigue to the point where a rest period occurs before the tool user fatigues.

For the estimated 20% of the population that is predisposed to CTD, no hand-operated tool is going to eliminate the problem. Assessing the work and the people doing the work is essential in choosing appropriate tools. Some form of automation, such as a pneumatic tool, is indicated in high volume, repetitive motion work situations.

Wire Strippers, Pliers and Forming Tools

XURON's new wire strippers are designed for simplicity, functionality and durability. Each model features a unique thumb-adjustable cam that can be set without the need for additional tools. For added versatility, a built-in full by-pass shear cutter is designed into each tool.

XURON Tweezer Nose™ and Xuro-Grip™ pliers deliver high precision at reasonable cost. Primary design criteria are precision, ergonomics and durability.

XURON wire strippers, pliers and forming tools feature advanced ergonomic designs, Xuro-Rubber™ cushioning grips, light weight, a glare-eliminating black finish and our Light Touch™ return spring. All are optionally available with static control (AS) grips.

new

501 Wire Stripper/Cutter

A simple, yet highly effective wire stripper. Manufactured from .100" thick high carbon steel, the 501 is designed to cut and strip all wire sizes from 10-26 AWG (2.59-0.405mm). Thumb adjustable cam is quickly and easily set to the desired size, requiring no additional tools and no need to know the exact diameter of the wire. Can be used for both solid and stranded wire. Light weight, Xuro-Rubber™ grips and Light Touch™ return spring combine for operator comfort and ease of use.

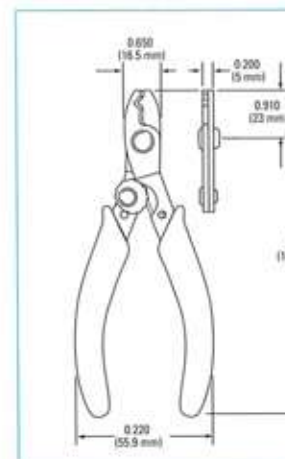

new

505/505ST Wire Stripper/Cutter

Similar in design to the model 501, but with the added benefit of having wire gauge markings on the cam and a handy closure "hook" that keeps the tool in a closed position when not in use. Model 505 is designed for solid wire from 12-26 AWG (2.05mm-.405), model 505ST for stranded wire. Both models feature Xuron's Light Touch™ return spring and cushioned, non-slip Xuro-Rubber™ grips.

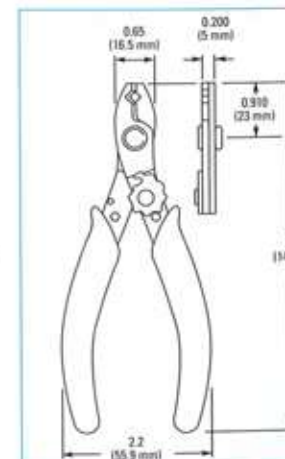

450 Tweezer Nose™ Plier

The 450 is an ultra-precise needlenose plier capable of grasping and holding wire less than .010" thick with the strength for wire forming. Leads "popping" free, tip mis-alignment and blade crossover will be a memory once you switch to our Tweezer Nose™ pliers. Radiused edges protect lead wires. Light weight and our patented, non-protruding, *Light Touch™* return spring help ensure operator comfort.

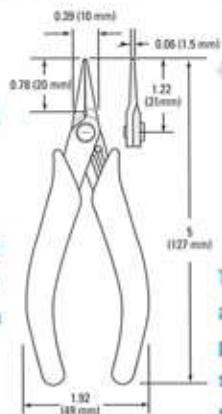

The model 450 is also available with fine, perpendicular-to-the-jaw serrations for extra holding power (model 450S).

new 450BN Bent Nose Plier

Strong and precise plier blades angled to 45° for improved sight lines when working in tight areas or with small parts. Plier tips are perfectly aligned and capable of picking up a human hair or forming and holding wire. Glare-eliminating black finish, non-slip Xuro-Rubber™ grips and *Light Touch™* return spring combine to ensure operator comfort even during periods of extended use.

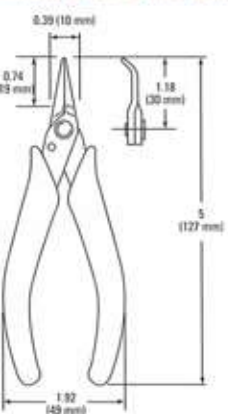

475 Xuro-Grip™ Short Nose Plier

High carbon steel for strength and an extra-thin profile to allow access in high density areas. The strength to crimp a lead wire with the precision to grasp and hold a human hair. Plier features a glare-eliminating black finish, ergonomically-shaped, non-slip Xuro-Rubber™ grips and light weight for operator comfort.

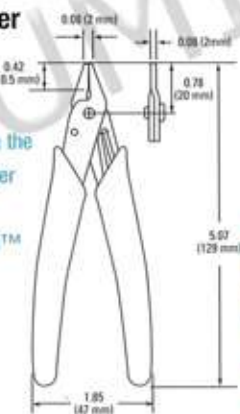

The model 475 is also available with fine, perpendicular-to-the-jaw serrations for extra holding power (Model 475S).

475C Combination Shear/Short Nose Plier

A true multi-purpose tool, combines a full by-pass shear with a precise short nose plier. Extra strong, high carbon steel plier has the power to grip and the precision to hold a human hair. Shear cuts everything from small wires up to 12 AWG (2.05mm) copper wire.

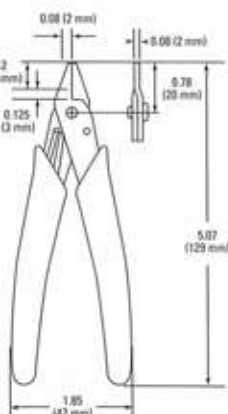

485 Xuro-Grip™ Long Nose Plier

A true "electronics production long nose plier" is what we had in mind when we designed the 485. Engineers and production managers told us traditional drop-forged designs were too bulky and lacked the sensitive "feel" required for precision electronic assembly. Our 485 performs where the competition failed. 485 features a thin profile for access in high density areas, radiused outside edges, ergonomically-shaped, non-slip Xuro-Rubber™ grips, a glare-eliminating black finish and light weight for operator comfort. The model 485 is also available with fine, perpendicular-to-the-jaw serrations for extra holding power (Model 485S).

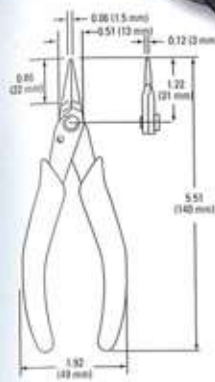
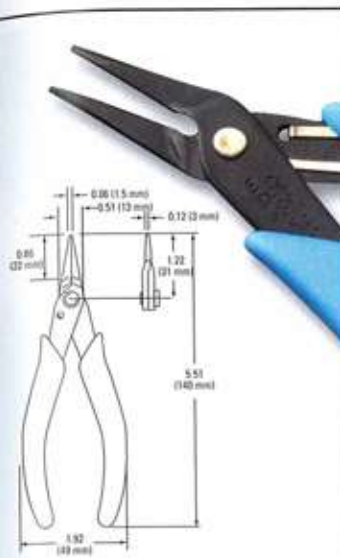

new 485C Combination Shear/Long Nose Plier

The combined benefits of a full by-pass shear cutter and a precision electronics long nose plier in one tool. Heat-treated, durable, high carbon steel blades allow a cutting range from the smallest wire up to 12 AWG (2.05mm) copper wire. Plier blades are tapered for access into restricted work areas and have radiused outside edges for forming wire without damage or scarring. Non-protruding *Light Touch™* return spring speeds work while cushioned, non-slip Xuro-Rubber™ grips provide comfort.

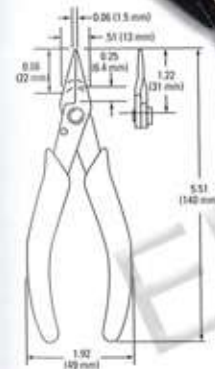

new 485FN Flat Nose Plier

A flat nose (duck bill) version of our Model 485 Long Nose Plier. Flat, smooth blades are perfect for wire bending or forming operations. As with all Xuron pliers, the 485FN features a glare eliminating black finish, ergonomically shaped Xuro-Rubber™ grips, and light weight for operator comfort.

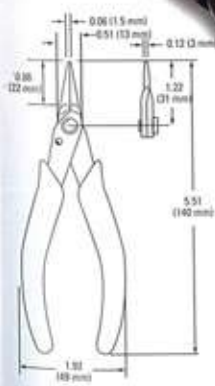
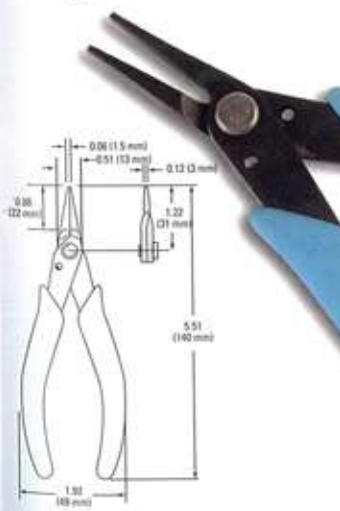

488 Round Nose Plier

Traditional double-round design with an innovative difference. Conventional round tip transitions to an elliptical shape along the length of the blades. This design allows for more forming possibilities and exceptional tip strength. Ideal for forming or looping of very fine wires in precision work. Xuro-Rubber™ grips and light weight ensure operator comfort.

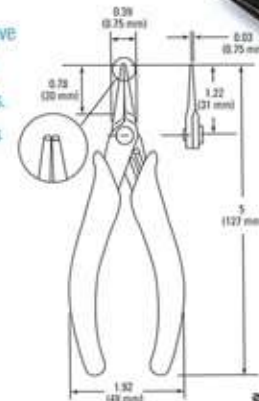
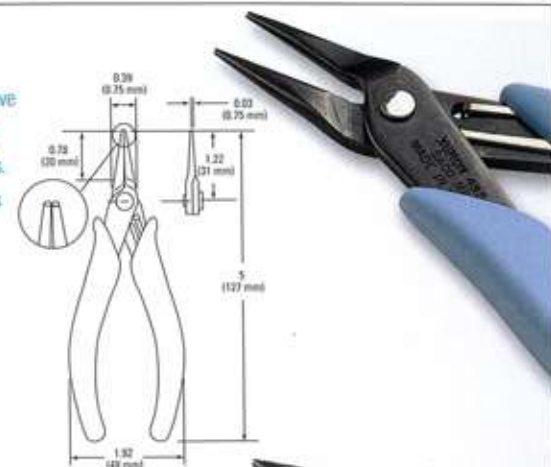

489 Combination Tip Plier

Traditional one round/one flat design offers easy coiling, forming and bending - all with one plier. An extremely durable tool with exceptional tip strength and precision closure. Glare-eliminating black finish, non-slip Xuro-Rubber™ grips and light weight ensure operator comfort.

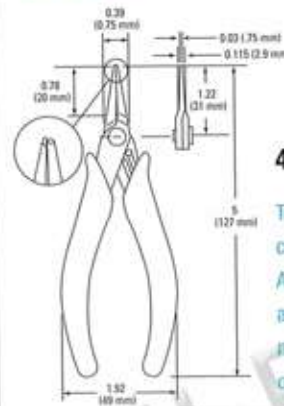
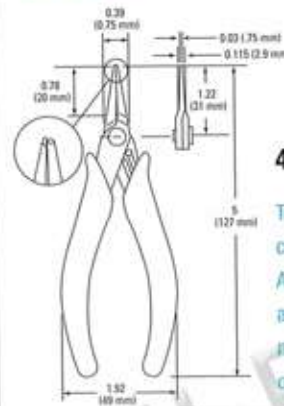

573 Xuro-Former™ Lead Forming Tool

The patented, original strain-relief forming hand tool. Radius and depth of bend are controlled by a simple slide adjuster, which locks firmly in place to prevent unintended setting changes. This high carbon steel tool features light weight, glare-eliminating black finish and ergonomically-shaped, non-slip Xuro-Rubber™ grips. Forms lead wires up to 0.030" (0.8mm).

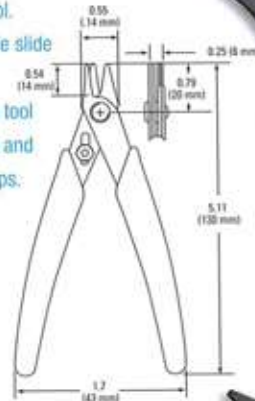

573L Xuro-Former™ Lead Forming Tool

The same great features as our 573 Xuro-Former™ but designed to form wires up to 0.050" (1.3mm).

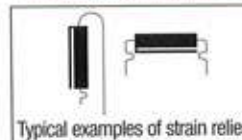

Typical examples of strain relief.

specialty products

Rover Mask™ 775 is a premium quality, latex, temporary solder resist suitable for both manual and automatic dispensing. A 10 mil coating of the non-running, thixotropic (18,000-22,000 C.P.S.) jell dries in 3 hours at room temperature or 1 hour at 160°F. (71°C). Once cured, Rover Mask™ 775 will not lift or separate during soldering. It is exceptionally cohesive, generally peeling off in one piece, simplifying removal. Once cured, bio-degradable, non-toxic Rover Mask™ 775 can be disposed of with other common, solid wastes. It has a shelf life of one year and is suitable for use as a conformal coating.



Rover Mask™ 775-8

This convenient 8 ounce (227g) applicator bottle features a tapered spout for easy application. Inner safety seal keeps mask fresh and prevents spillage in transit.



Rover Mask™ 775-1

Rover Mask™ is available in a one gallon (8.25lbs/3.75kg) bottle for refilling 8 ounce applicator bottles or for loading automatic or semi-automatic dispensing systems.

Rover Mask™ 775-55

The most economical way to purchase Rover Mask™ 775 is in this 55 gallon drum. Sold by weight, not volume (approx. 8.25lbs/gal.).

*** Rover Mask™ - Because we couldn't call it Spot.**

590 Micro-Pneumatic™ Flush Cutter

For a light weight, fast-action, ultra-quiet, pneumatic Micro-Shear® flush cutter, choose the 590. It requires only 50 p.s.i. air pressure. Flush cuts soft wires up to 16 AWG (1.27mm)

590F Micro-Pneumatic™ Flush Cutter w/Lead Retainer

Our 590 is also available with a factory installed lead retainer (590F). Its design provides a low profile and non-slip mount on the cutter head that helps prevent flying lead problems that result in component shorting.

590LP Low Profile Head Micro-Pneumatic™ Flush Cutter

The 590LP's relieved head and slim profile allows superior access in high density areas. Flush cuts soft wire up to 20 AWG (0.8mm)

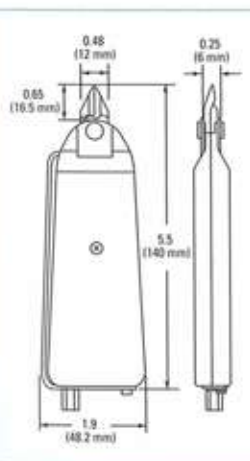

Specifications		
Length	5.5"	(139mm)
Width	1.9"	(48.2mm)
Thickness	0.6"	(15mm)
Weight	6 Oz.	160 grams
Length of cut	0.35"	(9.0mm)
Operating pressure	50 PSI max.	3.4 ATM
Maximum capacity	0.050	(1.27mm) soft wire

Micro-Pneumatic™ Series tools are the latest in advanced ergonomic design. Sized to fit readily in the operator's hand, they alleviate the fatigue and related CTDs (cumulative trauma disorders) associated with conventional wire cutter use. Easily actuated by light pressure with either the thumb or forefinger, 590 Micro-Pneumatic™ cutters can be quickly adapted to either right or left-handed use. Designed specifically for the manufacturing environment, the overall size of the tools allow for excellent maneuverability and access into restricted areas, a significant advantage with today's high density electronics packaging. Micro-Pneumatic™ cutters feature quiet (<60 dbA) operation and light weight (6 oz.) addressing two important fatigue factors. The cutter heads are treated with a glare-eliminating black finish for excellent contrast with the work surface and for reduced eye strain. The cutter heads feature Xuron's patented Micro-Shear® cutting action for ultra-clean, ultra-flush cuts. Manufactured from high carbon steel and heat treated to a Rockwell hardness of 58-59C, Xuron Micro-Pneumatic™ tools are exceptionally durable. The 590 Micro-Pneumatic™ is rated for soft wires less than 1 mil. all the way up to 16 AWG and is suitable for cutting a variety of other materials, including plastics. The design of the 590 ensures quick and easy cutter head replacement. It operates from a dry, unlubricated 50 p.s.i. air line, consuming just 0.13 cubic feet of air per minute of operation. Micro-Pneumatic™ cutters come equipped with a six-foot air supply line with a 1/8" MPT termination.